

VONAX

specification of C900E-USB display

C900E-USB Instructions



CONTENT

1.About the user manual	1
2.Outlook and size	2
2.1Material and color	2
2.2 Button definition	3
2.3 Installation method of bracket adjusting washer	4
3.Function summary	5
4.Setup summary	6
4.1 General Setup	6
4.1.1 Trip Clear	6
4.1.2 Backlight setting	6
4.1.3 Speed Limit setting	6
4.1.4 Wheel diameter setting	6
4.1.5 Units	6
4.1.6 Battery setting	6
4.1.7 Riding mode setting	7
4.1.8 Exit	7
4.2 Advanced setup	7
4.2.1 Current limiting setting	7
4.2.2 Poles In Motor setting	7
4.2.3 Start After Poles setting	7
4.2.4 Throttle 6KM	7
4.2.5 Throttle Level	8
4.2.6 Assist levels	8
4.2.7 Password	8
4.2.8 Exit	8
4.3 Information	8
4.4 Save & Exit	8
5.Wire order definition	9
6.Common problems and solutions	10
7.Quality & Warranty	11
8.Error code table	12

1.About the user manual

Dear users, in order to operate your electric car better, please read the C900E-USB instrument manual carefully before use. We will tell you every step of the instrument in the most concise language, from hardware installation and setup to normal use of the instrument. At the same time help you solve the confusion and obstacles that may arise.

2.Outlook and size

2.1Material and color

C900E-USB products are made of black Aluminum alloy material and the bracket is made of nylon material. Under the temperature of -20 to 60°C , the shell material can ensure normal usage and good mechanical performance of the products.

Dimension figure (unit: mm).

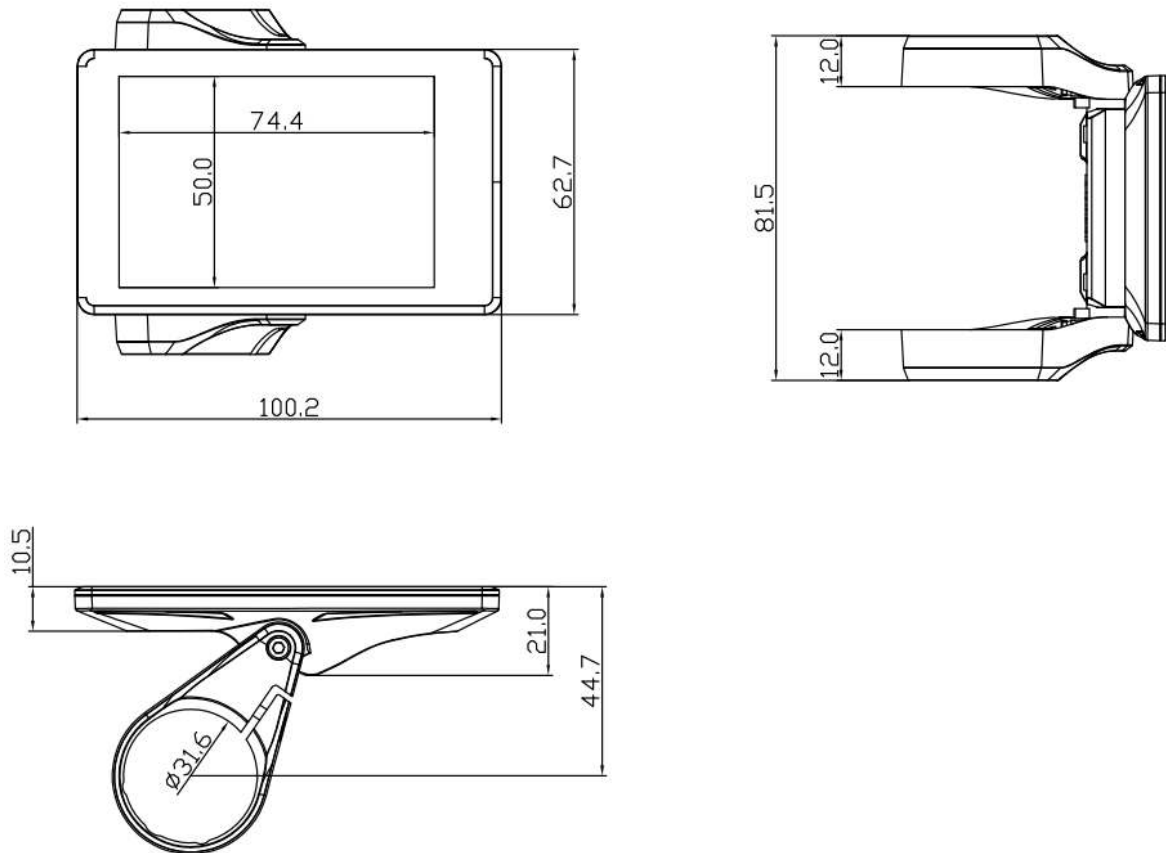

2.2 Button definition

C900E-USB has four buttons, including ON/OFF、SET、UP and DOWN.

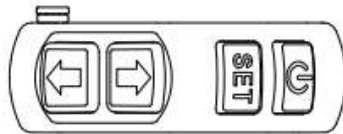
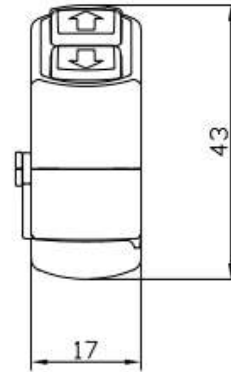
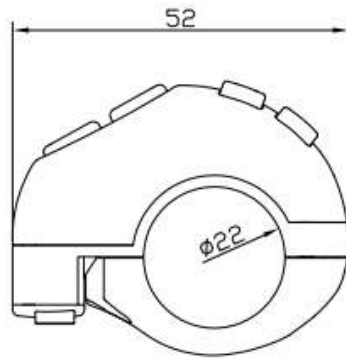

2.3 Installation method of bracket adjusting washer

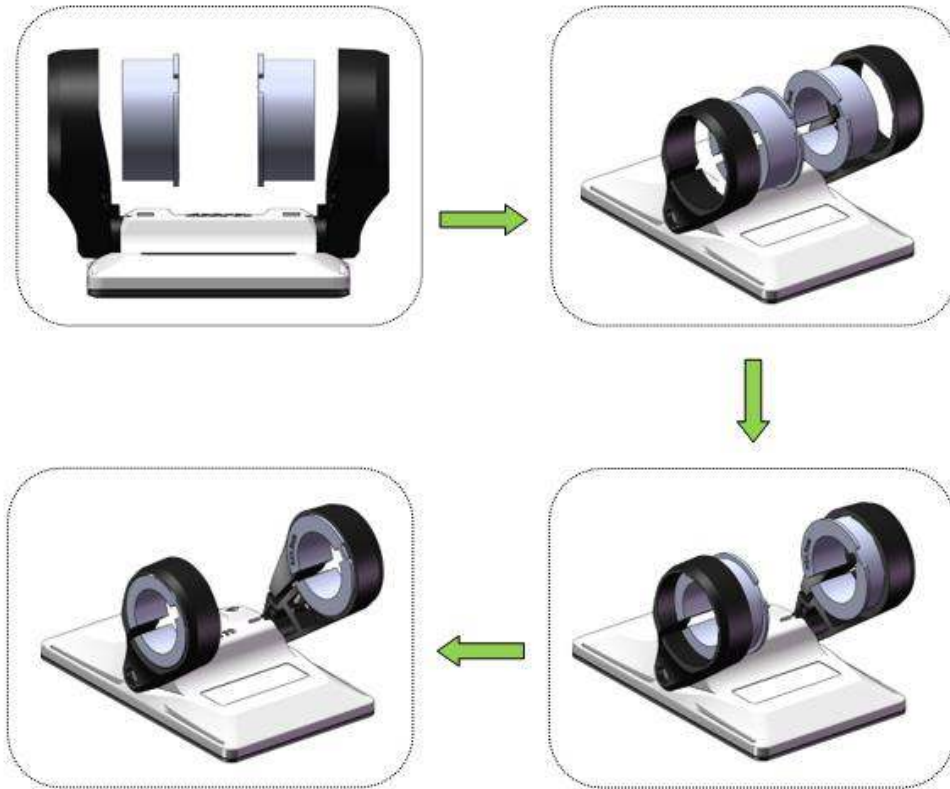

Note: The installation direction of the adjusting washer must be from the inside to the outside of the bracket.

3.Function summary

C900E-USB provides a wide range of functions and indicators to fit the users' needs. The indicated contents are as below:

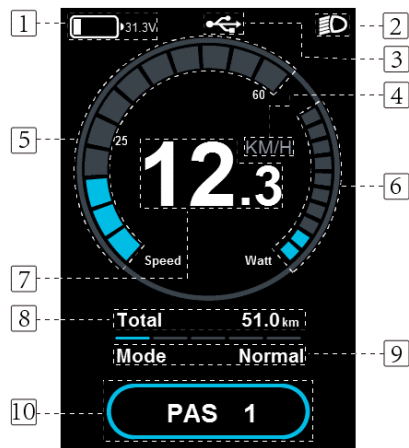

3.1 Electric quantity display:

Display current electric quantity.

3.2 Backlight indicator:

With the power on, click the ON/OFF to turn on the backlight and headlight.

3.3 USB

Hold the SET and UP for 5 seconds to get in USB.

3.4 Unit

Select KM/H or MPH as the current display unit.

3.5 Speed indicator:

Displays real-time speed in the form of a progress bar.

3.6 Power indicator:

Current real-time output power of motor.

3.7 Speed display:

Display the speed at present.

3.8 Information display:

- ◆ Trip: Display the user's single riding mileage.
- ◆ ODO: The ODO records the driving mileage from using, the accumulated value cannot be cleared.
- ◆ Time: Display the current time of a single ride.

3.9 Riding mode selection:

Three modes for riding, including POWER, NORMAL and ECO. Each mode corresponds to its interface theme skin.

3.10 Assist gear display:

- ◆ PAS: Display the current output power.
- ◆ 6KM: Hold the DOWN for 2 seconds to get in  6KM.

4.Setup summary

Click SET 2seconds enter the general setting interface.

4.1 General Setup.

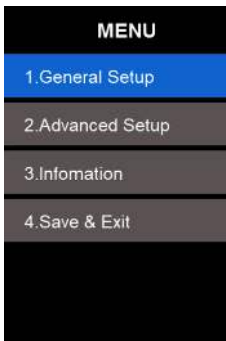

4.1.1 Trip Clear

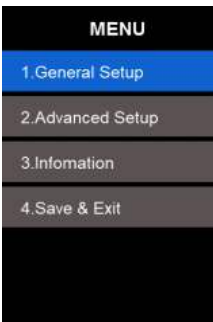

4.1.2 Backlight setting



4.1.3 Speed Limit setting



4.1.4 Wheel diameter setting



4.1.5 Units

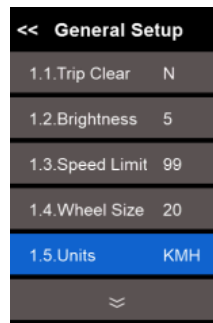

4.1.6 Battery setting

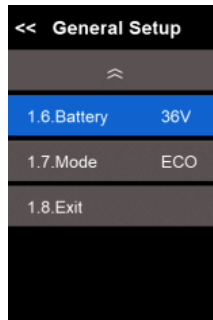

4.1.7 Riding mode setting

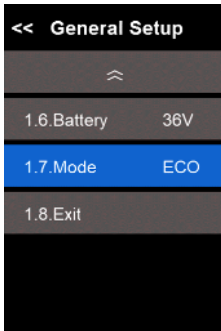

ECO:

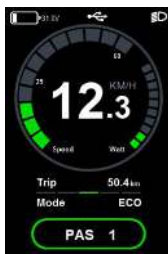

Normal:



Power:



4.1.8 Exit

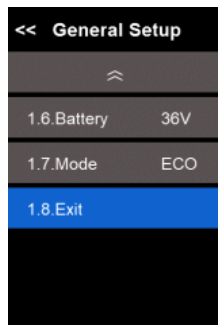

4.2 Advanced setup

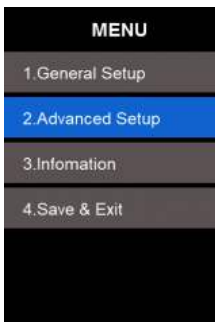

4.2.1 Current limiting setting

(Range:3-18).



4.2.2 Poles In Motor setting (1/6) .



4.2.3 Start After Poles setting (2-16)



4.2.4 Throttle 6KM

Y represents the turning knob into the 6KM pushing mode, and N represents the starting turning knob to the maximum.



4.2.5 Throttle Level

Y means throttle with different level, N means throttle with one level.



4.2.6 Assist levels

It can be set to 3,5,6,9. If user select 3, the range of assist levels is 1-3.

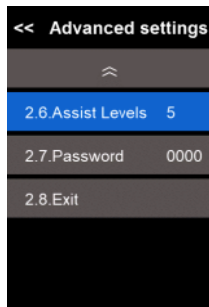

4.2.7 Password

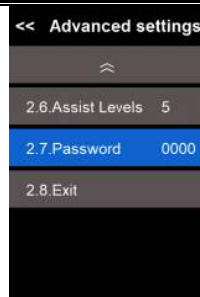

4.2.8 Exit

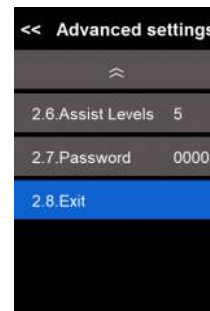

4.3 Information



4.4 Save & Exit.

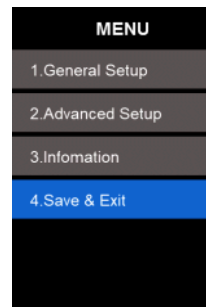

※ When the riding speed is 0 km/h for 5 minutes, the system will go to sleep automatically.

5. Wire order definition

Wires sequence	Wires color	Function
1	Red	Battery+
2	Blue	Weak lock
3	Black	Battery-
4	Green	UART - RECEIVE (RXD)
5	Yellow	UART - SEND (TXD)

6.Common problems and solutions

Q: Why the display is not able to start up?

A: Checking the connector that between display and controller.

Q: How to deal with the error code?

A: Fix it to the maintenance place immediately. If cannot be resolved, you can go to the electric vehicle repair points repair it in a timely manner.

7. Quality & Warranty

Any quality problems in normal case and in guarantee period, our company will responsible for the warranty

The warranty time is 18 months from date of purchasing.

Other items:

The following items are not belong to warranty scope

1. It can't be demolished.
2. The damage caused by wrong installation or operation.
3. Shell is broken when display is out of the factory.
4. Wire is broken.
5. Force disaster (such as fire, earthquake, etc.) or natural disasters like lightning, etc caused by fault or damage.
6. Beyond Warranty period.

8. Error code table

The error code is corresponding with the fault definition. :

Error code	Definition
0	Normal
1	Current error or MOS damaged
2	Throttle error(Start detection)
3	Motor no phase position
4	Hall error
5	Brake error(Start detection)
6	Under voltage
7	Motor stalling
8	Communication controller receiving error
9	Communication display receiving error